

Zelt-Bastelbogen

des VCP Stamm St. Thomas Volkmarode-Braunschweig

Liebe Pfadis,
mithilfe dieser Vorlagen lassen sich so ziemlich alle Zelte, die wir auf Pfadfinderlagern aufbauen zuhause nachbasteln. Zur Auswahl stehen schwarze, weiße und rote Zeltbahnen. Sucht euch die passenden Teile für euer Zelt heraus. Es werden nur wenige weitere Materialien benötigt.

Ihr braucht:

1. eine Schere
2. einen Klebstift
3. ein paar Schaschlik-Spieße
4. Für eine Kothe: 1x Blatt 1 ausdrucken
 Für eine Jurte: 3x Blatt 2 ausdrucken
 Für eine Hoch-Kothe: 2x Blatt 2 ausdrucken

Für alle, die noch nicht genug haben, bietet das Blatt 3 weitere Zeltplanen, mit denen ihr die wildesten Konstruktionen aufbauen könnt (Fenster-, Theater- und Rechteck-Bahnen).

Wir wünschen euch viel Spaß beim Basteln und kreativ sein.

Gut Pfad!

PS: Wer Tinte sparen will, kann auf farbigem Papier drucken.

Blatt 1 – Kothe (schwarz)

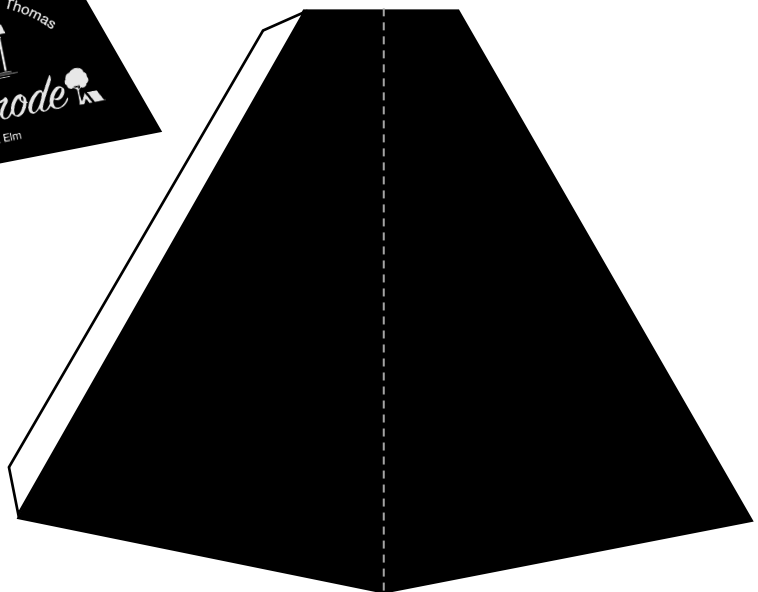
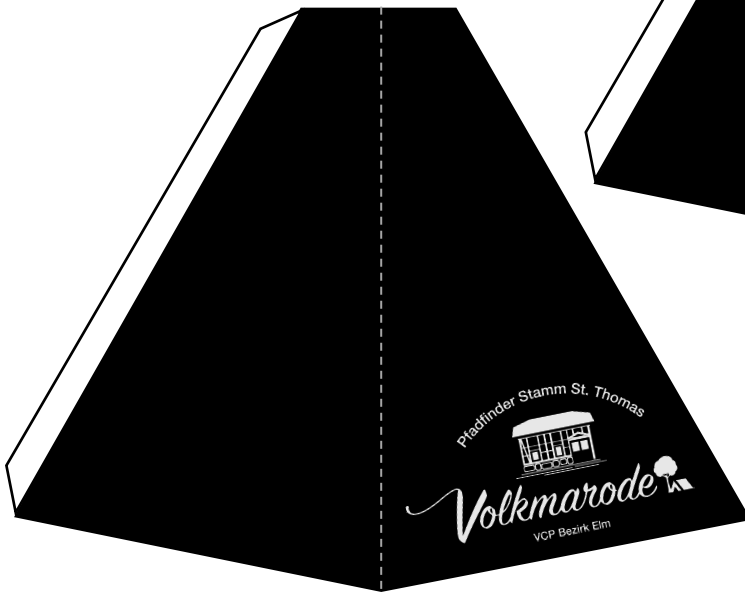
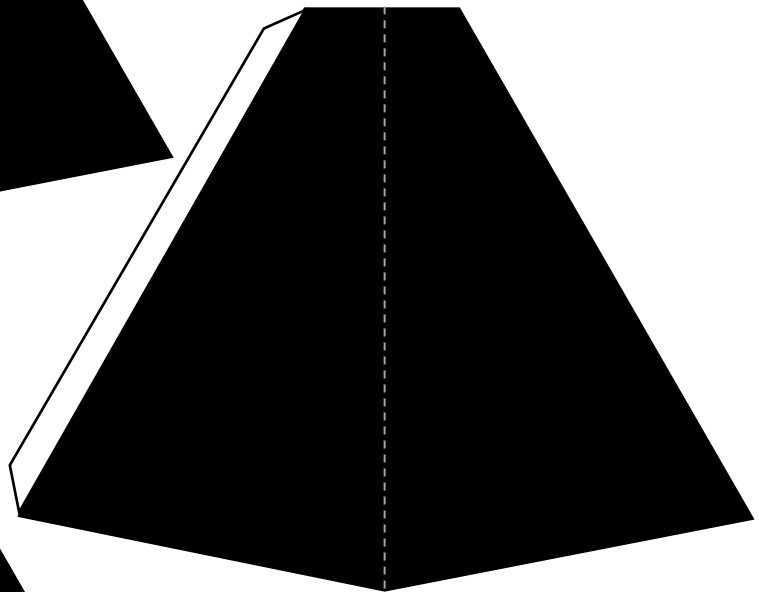
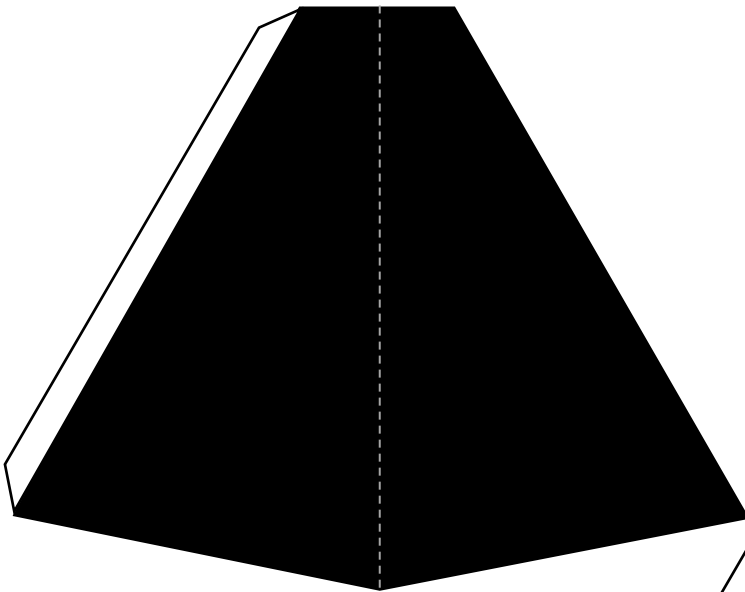

Blatt 2 – Jurte (schwarz)

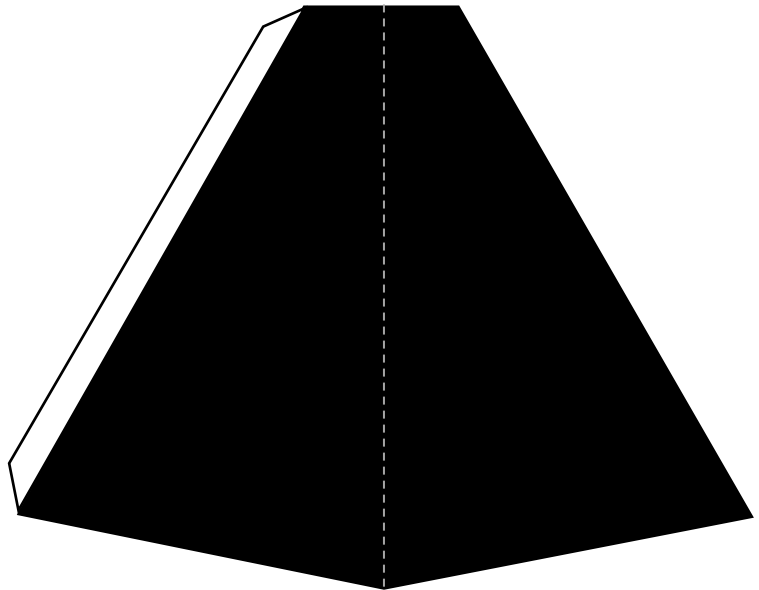
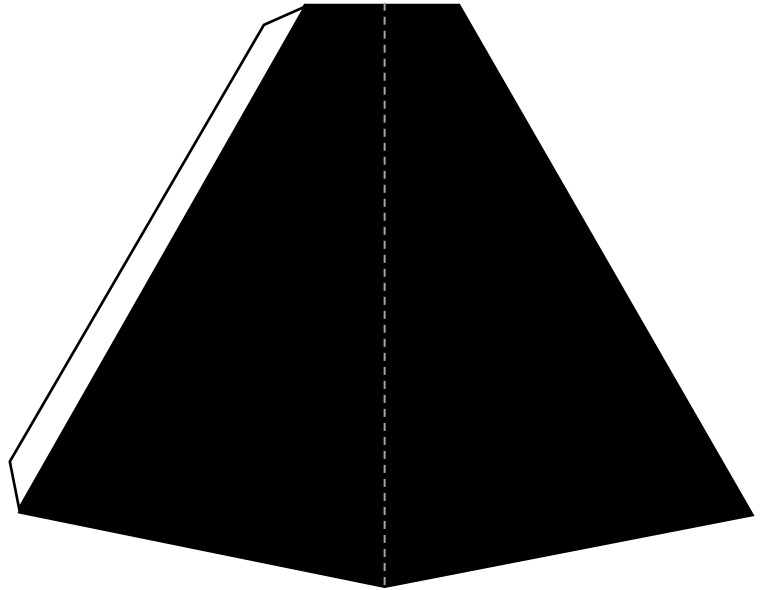
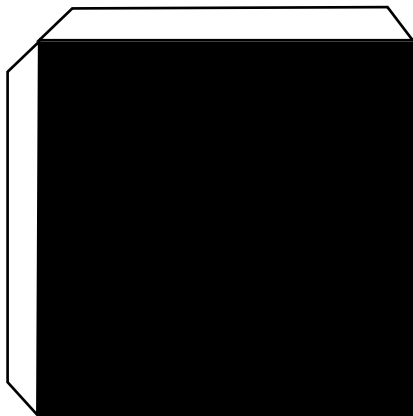
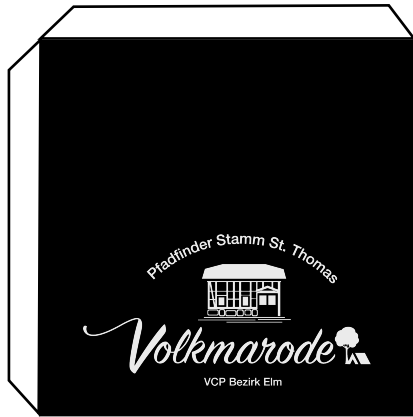
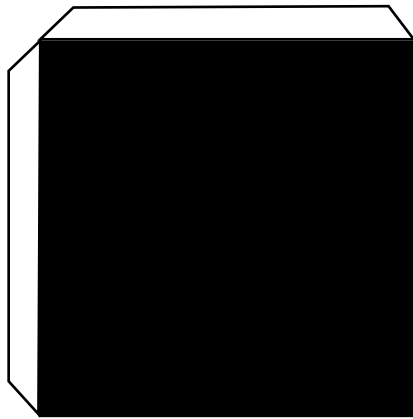
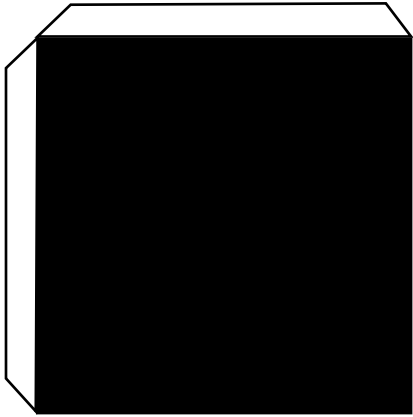

Blatt 3 – diverse Planen (schwarz)

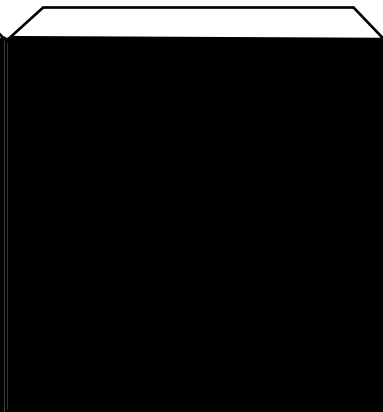
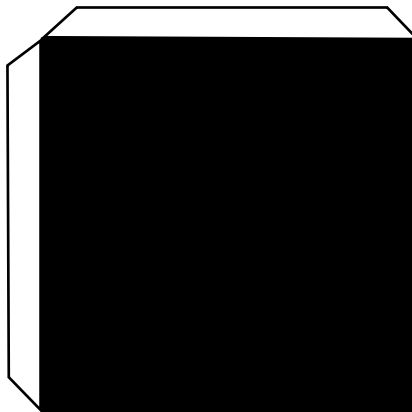
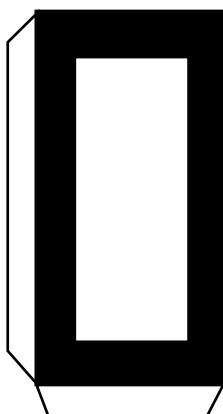
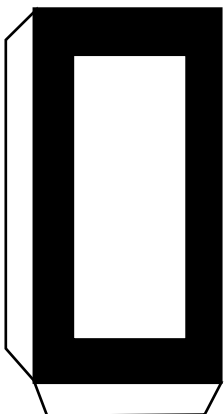
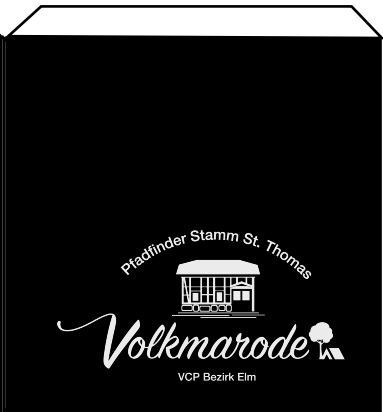
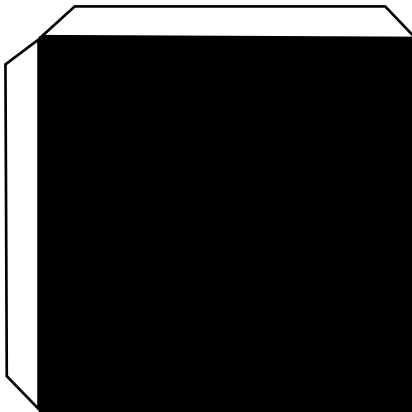
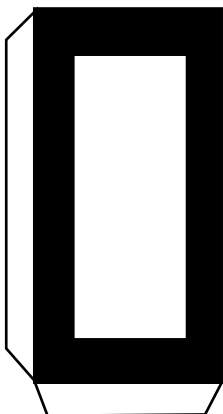
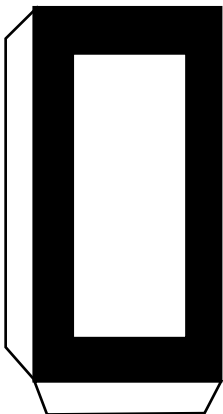
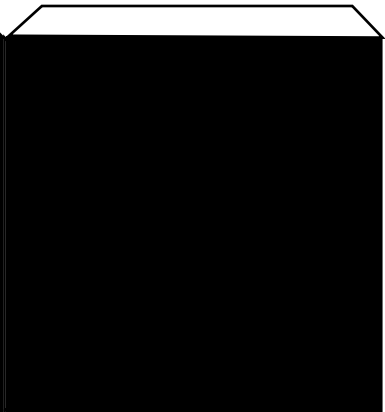
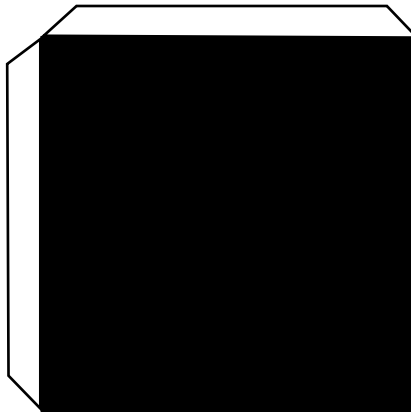
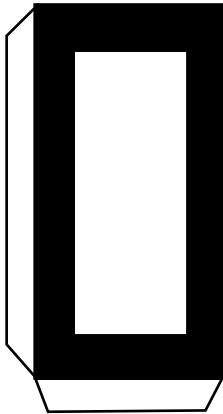
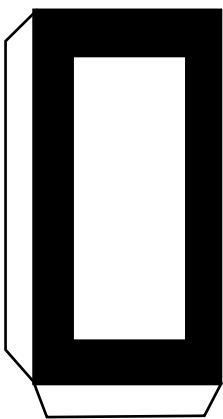

Blatt 1 – Kothe (weiß)

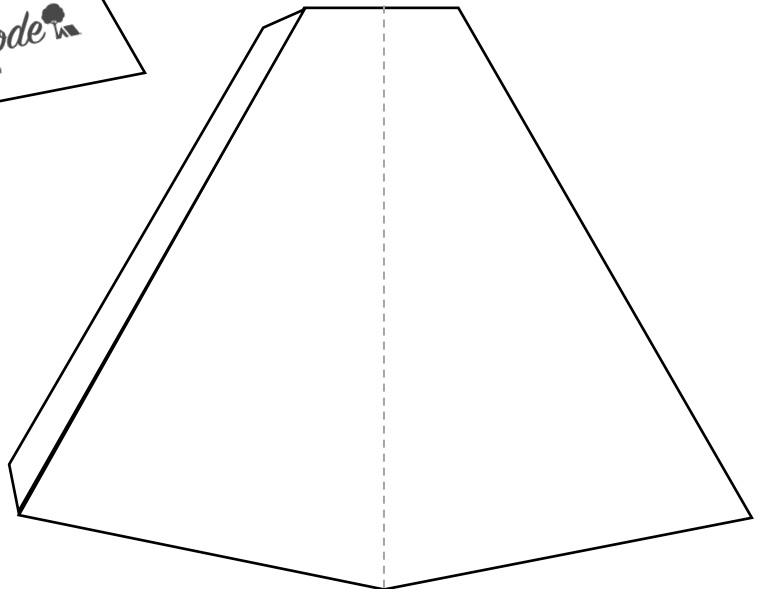
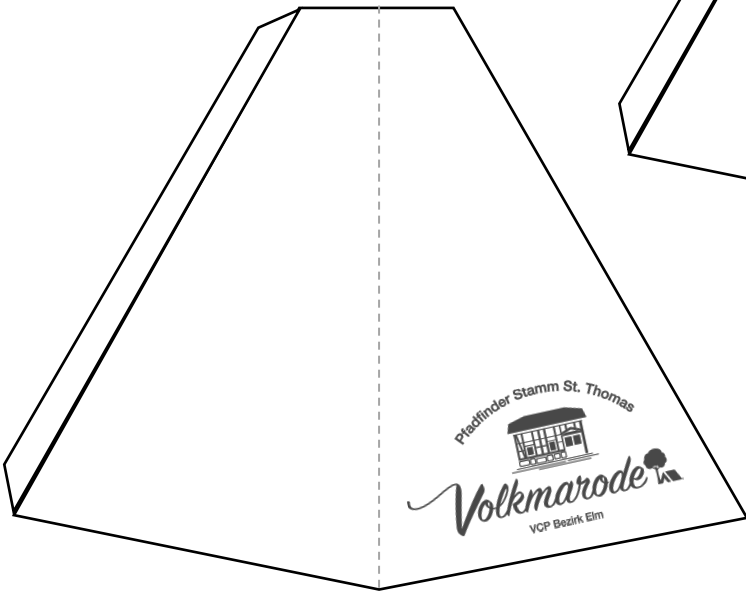
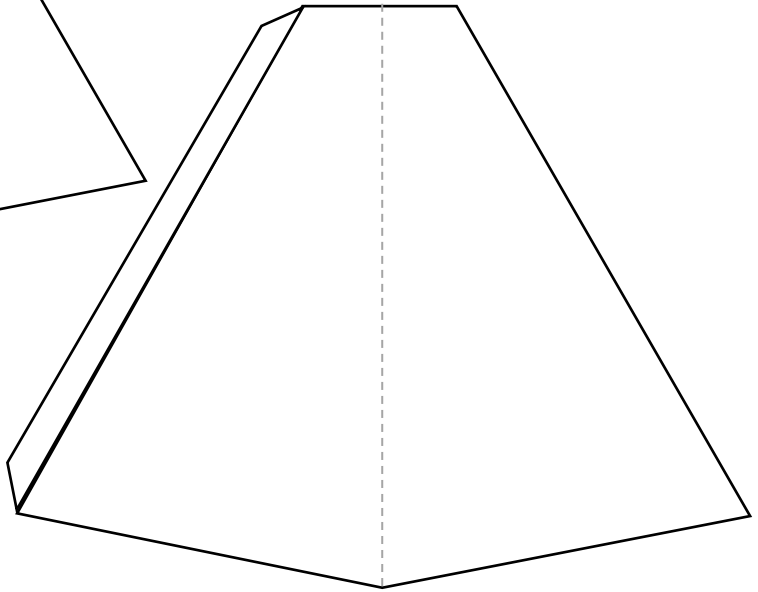
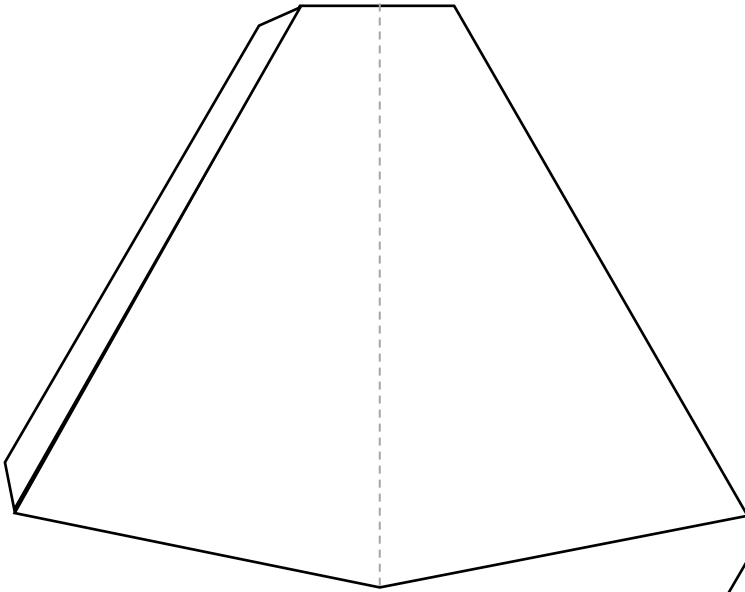

Blatt 2 – Jurte (weiß)

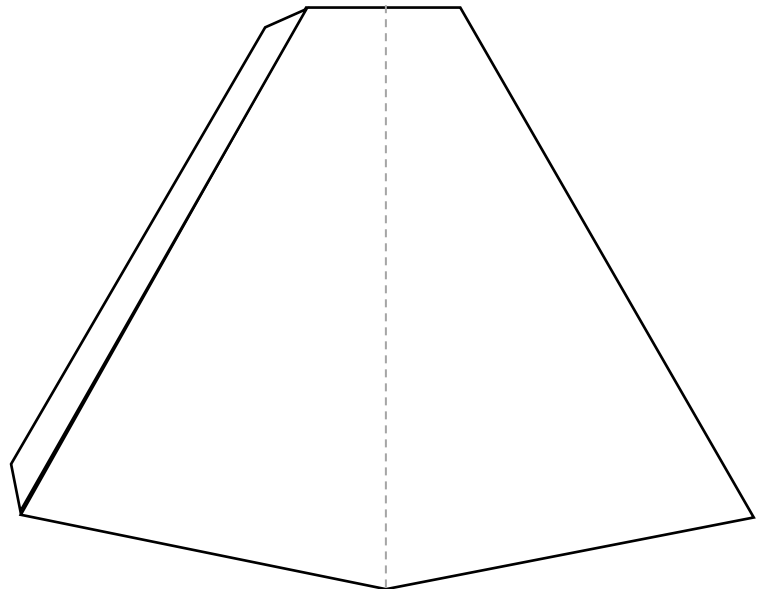
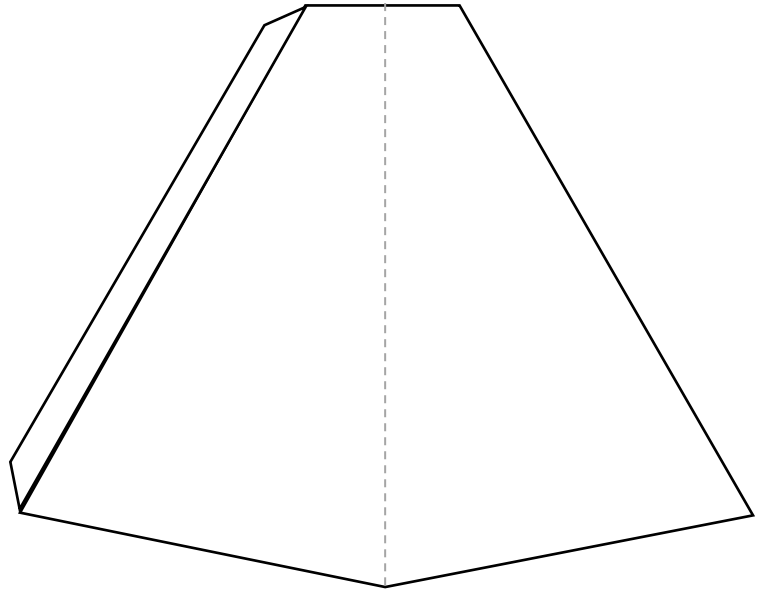
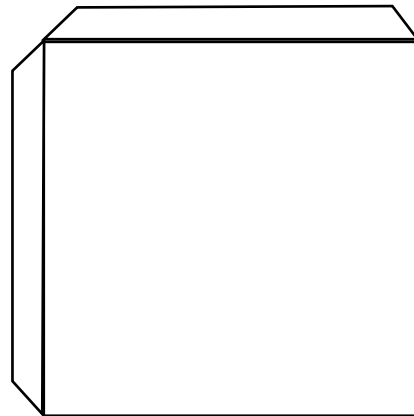
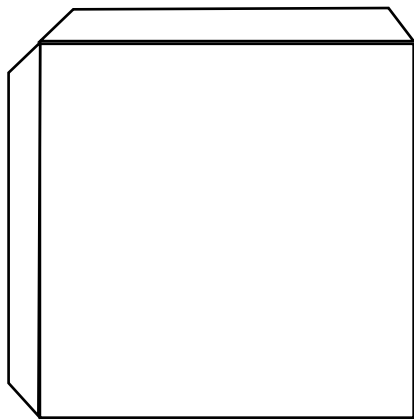
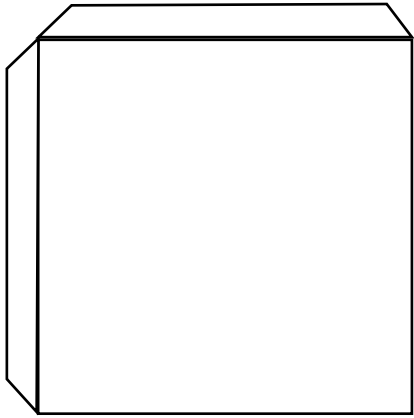

Blatt 3 – diverse Planen (weiß)

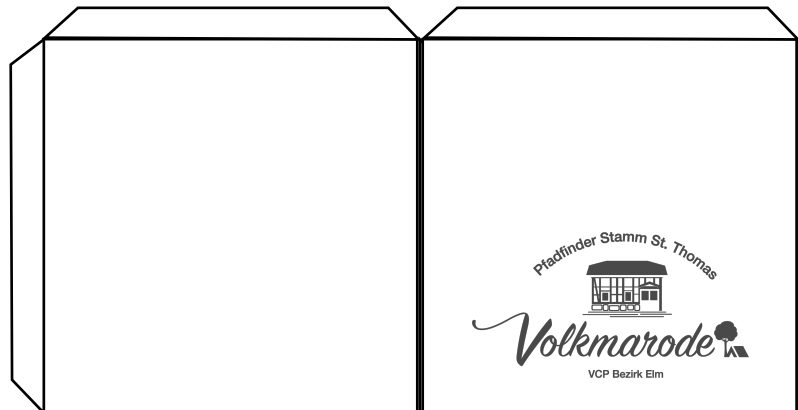
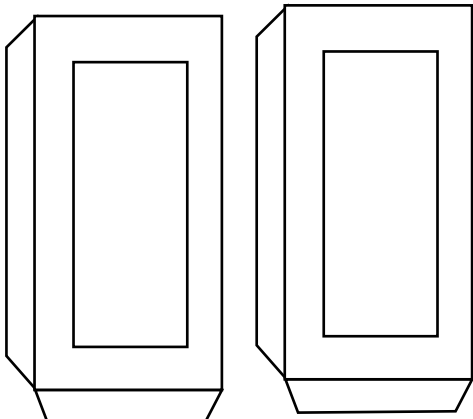
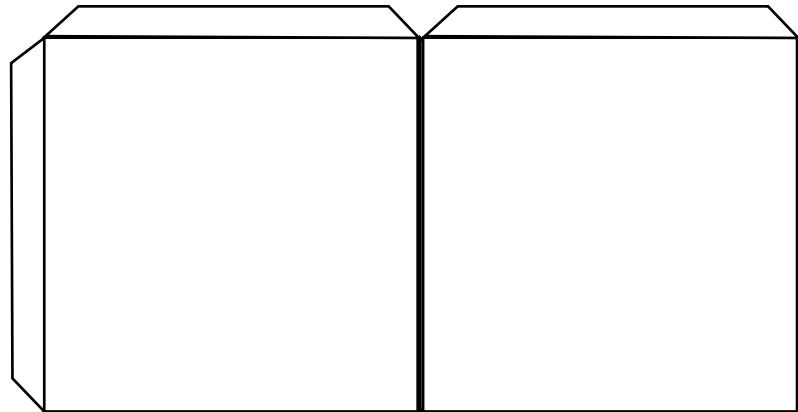
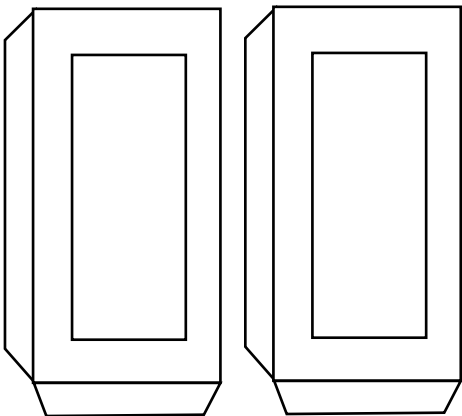
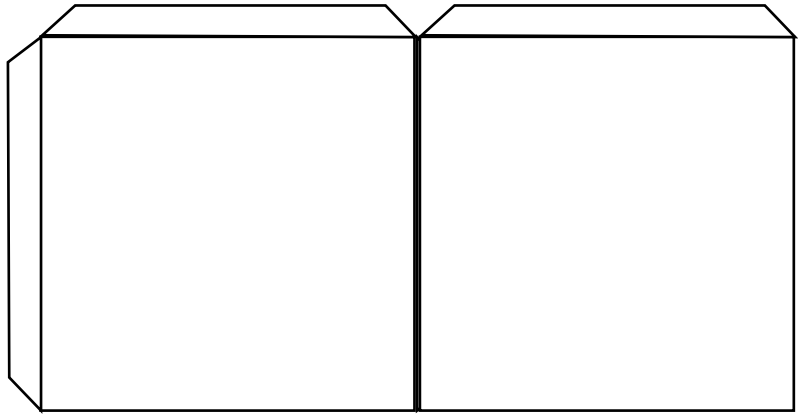
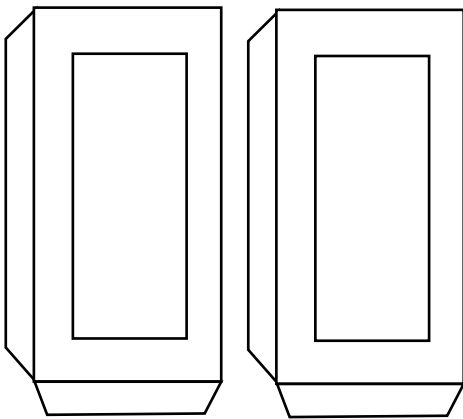
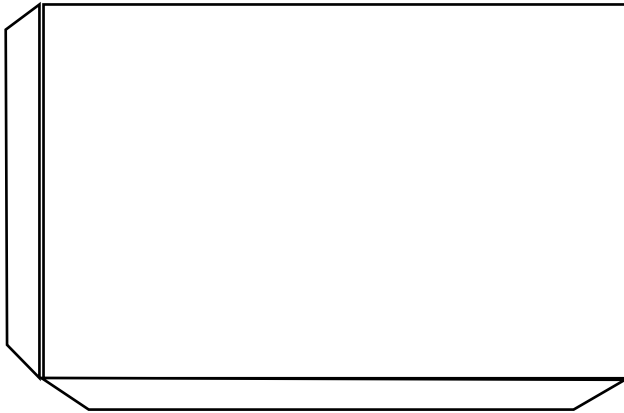

Blatt 1 – Kothe (rot)

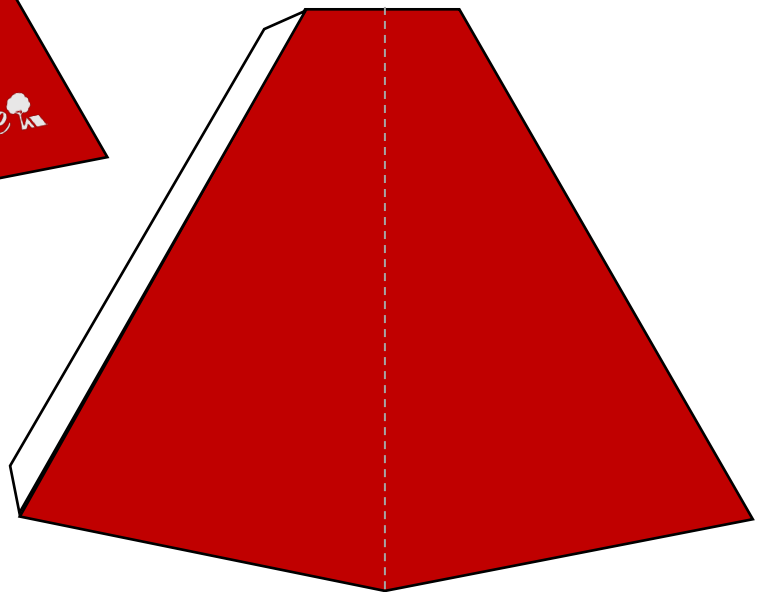
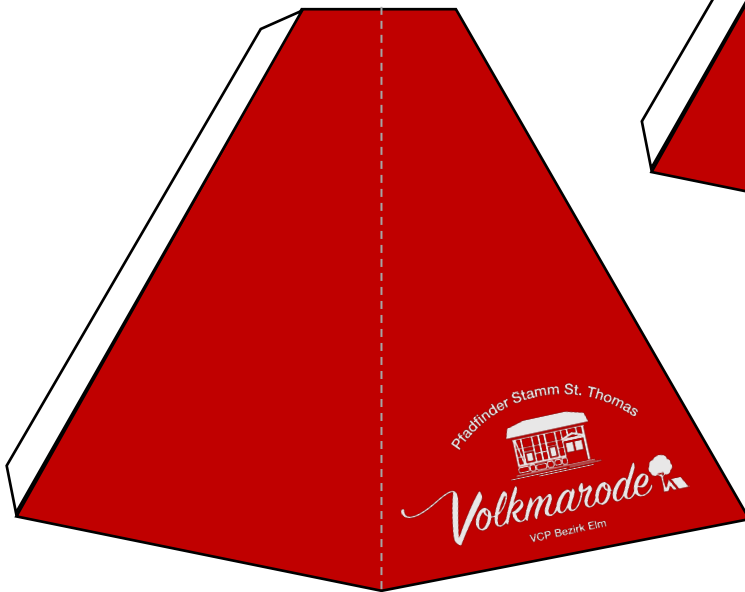
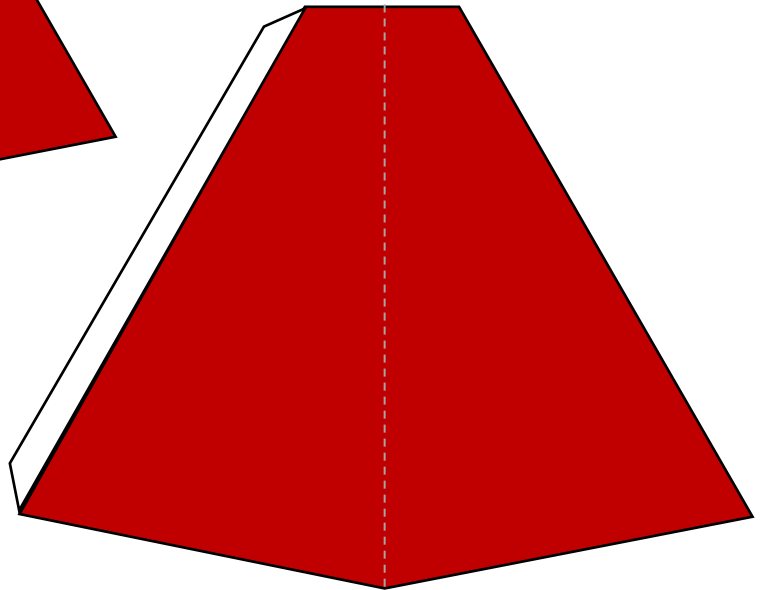
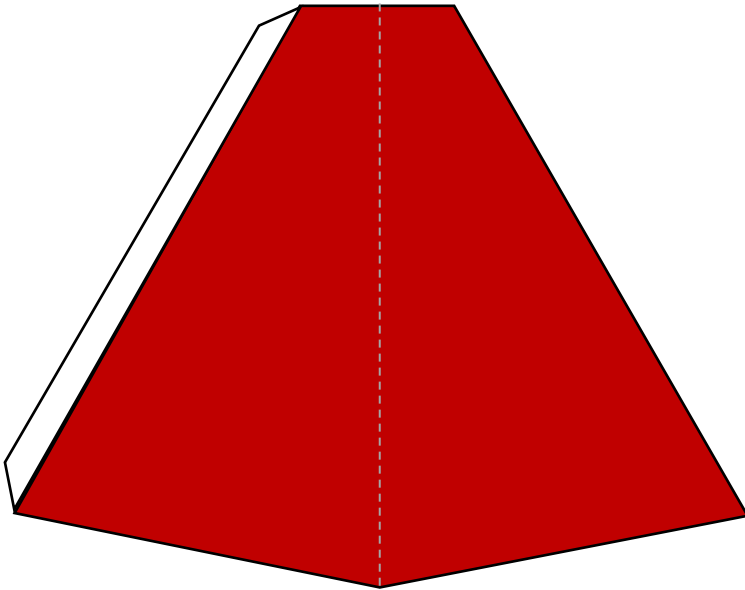

Blatt 2 – Jurte (rot)

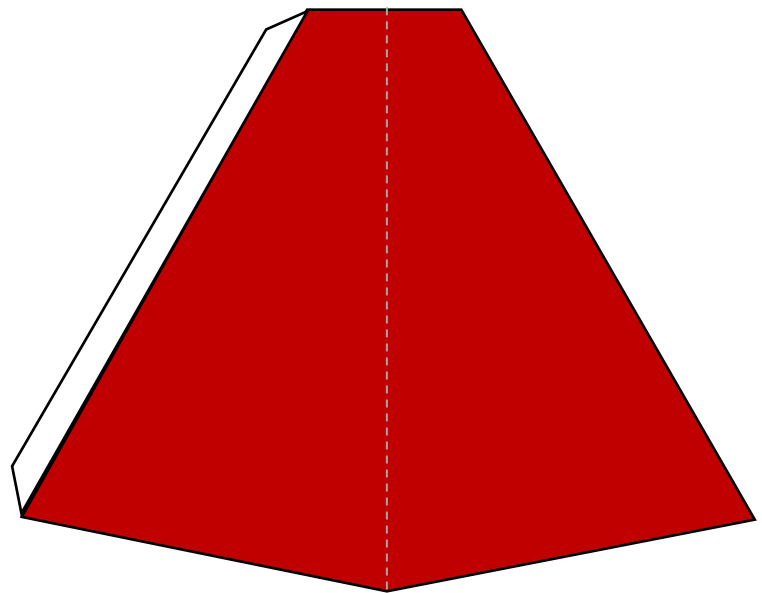
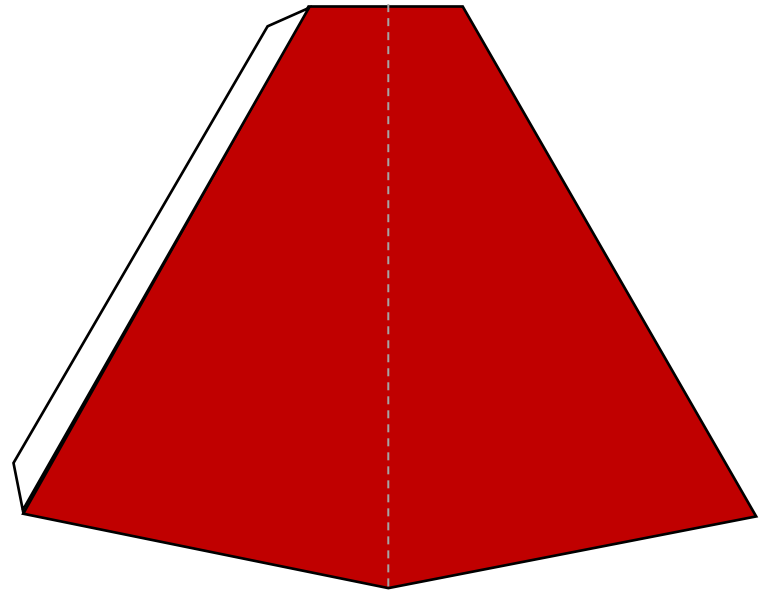
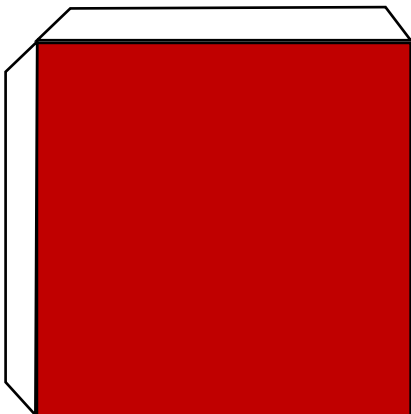
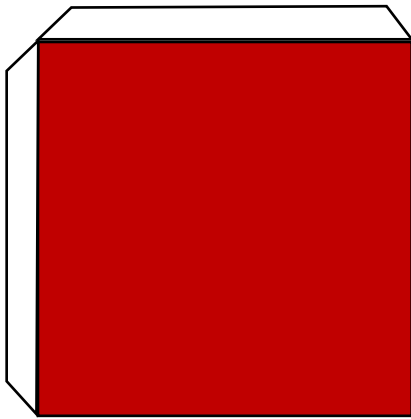
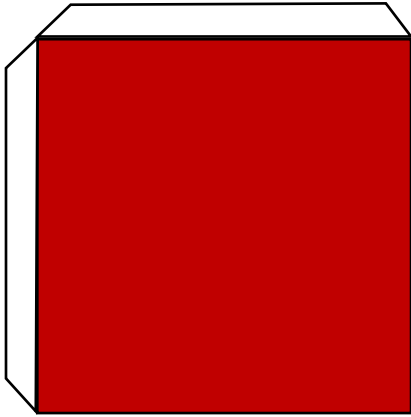

Blatt 3 – diverse Planen (rot)

